



ELEKTROTEKNIK



E-KABIN E SERIES

WALL- MOUNTED DISTRIBUTION SWITCHBOARDS

DUVAR TİPİ TESİSAT KABİNLERİ

www.eae-et.com.tr



ELEKTROTEKNIK

CONTENTS

Description	1
Easy Workshop Assembly	3
Easy on-site Installation	5
Order Information	9
Covering Elements	11
Accessories	13
Custom Solutions	14



E-Kabin E Series Distribution Switchboards

E-Kabin E Series distribution switchboards are designed especially for indoor electrical installation applications of shopping centers, hotels, hospitals and etc. Their design allows use of equipment suitable to be fixed on DIN-rail.

Application	: indoor, dry environment
Protection class	: IP 55, glazed door IP 40
Type of mounting	: wall-mounted
Framework	: 2 mm galvanized sheet steel
Paint	: epoxy - polyester powder paint
Colour	: standard RAL 7035
Glass	: 4 mm tempered safety glass
Operating temperature	: -5°C, +40°C
Operating relative humidity	: +20°C at %90 +40°C at %50
Standards	: IEC 61439-1, IEC 62208 IEC 60529, IEC 62262

EASYWORKSHOPASSEMBLY

Aesthetical outlook

Frame pattern of tempered glazed door is specially designed for better view of phase indication lamps if used.

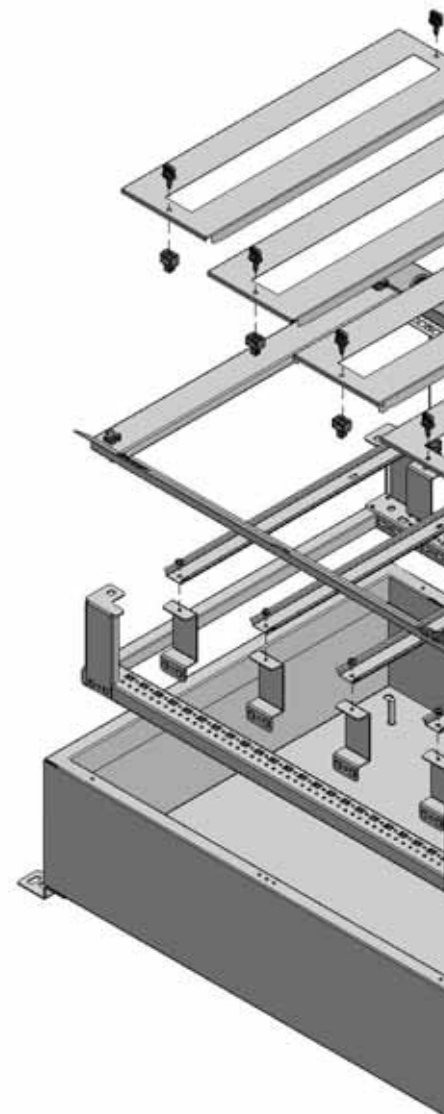

Elegant looking of electrical installation company logo and info under the glass is provided.



Fast and easy fixing of metal components during final assembly.

Assembly of mounting frame or plate requires minimal quantities of screws. Cover plates are easy and securely positioned by means of quarter-turn lock-pins.



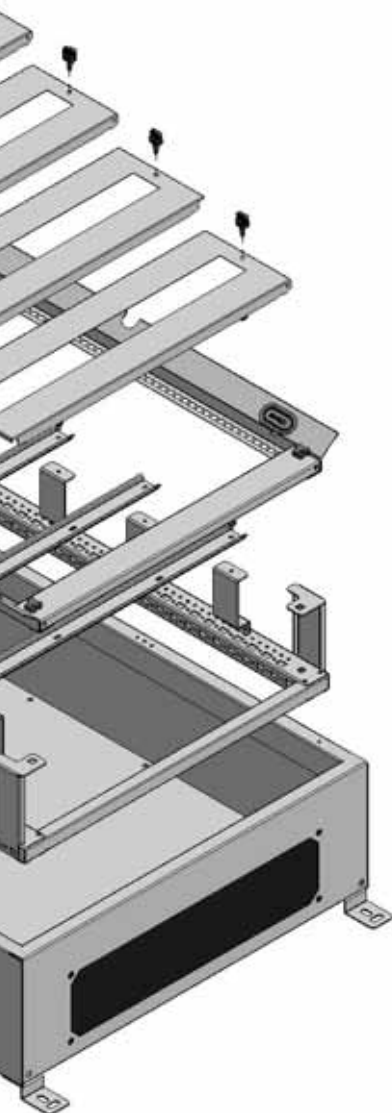

Easy planning

Thanks to the standard width 24/36 pieces of 18 mm units width devices can be used on each row.



24 units-nominal width of 60 cm
36 units-nominal width of 80 cm

Deep intermediate space behind the door.

Empty space of 70 mm depth between the door and cover plates allows mounting of measurement devices, rotary switches and etc. on door..

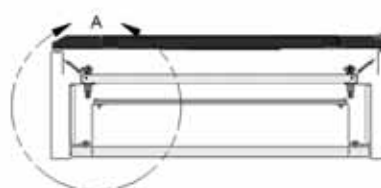

Ecological packaging

Original packing made of recyclable material can also be used for shipment after workshop assembly.

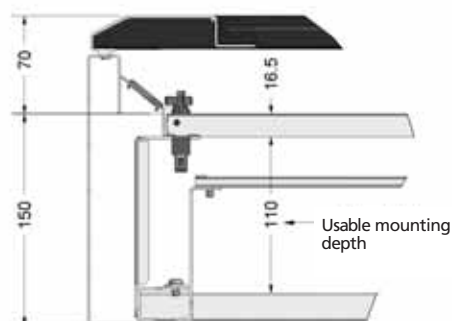

EASY ON-SITE INSTALLATION

Useful front door design

Locked or unlocked position of the door can be used by turning the handle of the locking system. Additionally, any unauthorized use can be prevented by means of key-lock .



Key-lock is optional.



Wall fixing rails

Thanks to the optional wall mounting profile (refer to page 13) cables can be passed from the back side through the top to bottom and then can enter the switchboard through the bottom.



Bidirectional door opening

Door opening direction can be changed if it is needed.

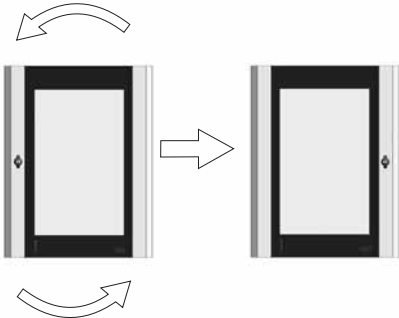



Easy external cable connection

Cable entry is very easy from the outside. Special laminated cable gland can be easily bored by any sharp pointed tool for guiding required cable entry. It doesn't required to use any cable gland.

Cable entry hole dimensions and strength of cable gland plate allows 100 pieces of 4x2,5 mm² cable connection

Special laminated cable gland, applied in accordance with IEC 62208 and 61439-1 type test certificate of empty enclosures, successfully passes the Glow-Wire Test IEC 60695-2-10.



Quarter-turn cover plate lock-pins

Cover plates are easy and securely positioned by means of quarter-turn lock-pins

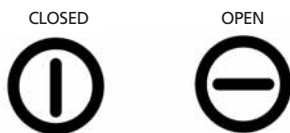





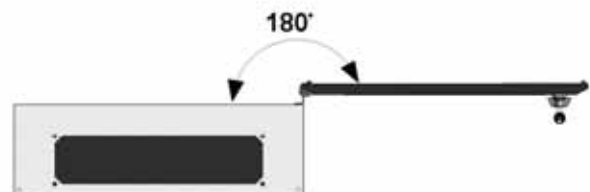





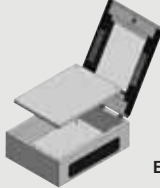
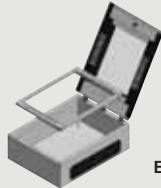

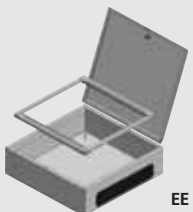
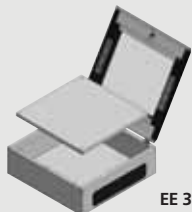

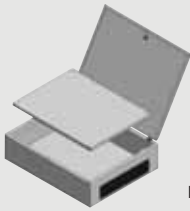



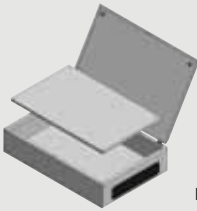

180° Wide Openable Door

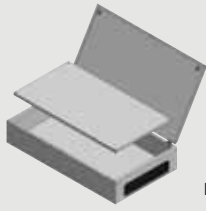
The door can be opened 180° wide. Thus full access is provided during installation

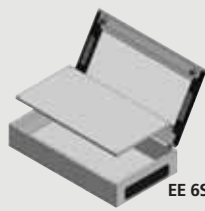

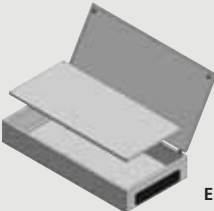
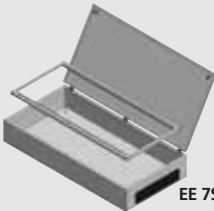
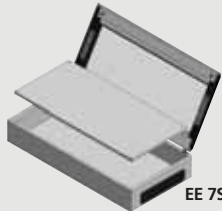











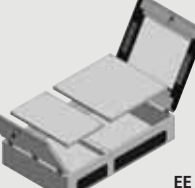

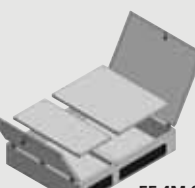

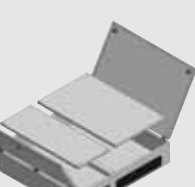

ORDER INFORMATION

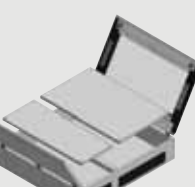
60 cm WIDTH				
	PLAIN DOOR		GLAZED DOOR	
	MOUNTING PLATE	MOUNTING FRAME INCLUDED	MOUNTING PLATE	MOUNTING FRAME INCLUDED
2 ROW 45x60x22 cm	 EE 2S 06 DP	 EE 2S 06 DF	 EE 2S 06 CP	 EE 2S 06 CF
3 ROW 60x60x22 cm	 EE 3S 06 DP	 EE 3S 06 DF	 EE 3S 06 CP	 EE 3S 06 CF
4 ROW 75x60x22 cm	 EE 4S 06 DP	 EE 4S 06 DF	 EE 4S 06 CP	 EE 4S 06 CF
5 ROW 90x60x22 cm	 EE 5S 06 DP	 EE 5S 06 DF	 EE 5S 06 CP	 EE 5S 06 CF
6 ROW 105x60x22 cm	 EE 6S 06 DP	 EE 6S 06 DF	 EE 6S 06 CP	 EE 6S 06 CF
7 ROW 120x60x22 cm	 EE 7S 06 DP	 EE 7S 06 DF	 EE 7S 06 CP	 EE 7S 06 CF

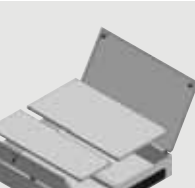
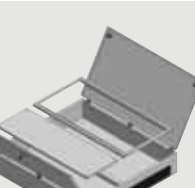
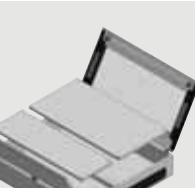
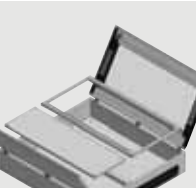

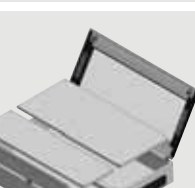





















Note: Wall mounting bracket set, cable gland plate, mounting frame or mounting plate are included.

40+60 cm WIDTH

	PLAIN DOOR		GLAZED DOOR	
	MOUNTING PLATE	MOUNTING FRAME INCLUDED	MOUNTING PLATE	MOUNTING FRAME INCLUDED
	2 ROW 45x100x22 cm	 EE 2M 06 DP	 EE 2M 06 DF	 EE 2M 06 CP
3 ROW 60x100x22 cm	 EE 3M 06 DP	 EE 3M 06 DF	 EE 3M 06 CP	 EE 3M 06 CF
4 ROW 75x100x22 cm	 EE 4M 06 DP	 EE 4M 06 DF	 EE 4M 06 CP	 EE 4M 06 CF
5 ROW 90x100x22 cm	 EE 5M 06 DP	 EE 5M 06 DF	 EE 5M 06 CP	 EE 5M 06 CF
6 ROW 105x100x22 cm	 EE 6M 06 DP	 EE 6M 06 DF	 EE 6M 06 CP	 EE 6M 06 CF
7 ROW 120x100x22 cm	 EE 7M 06 DP	 EE 7M 06 DF	 EE 7M 06 CP	 EE 7M 06 CF

























Note: The door of the narrow section is always projected to be plain.
 The narrow section is always projected to be plain mounting plate
 For different applications please, contact to your customer service representative.

ORDER INFORMATION

80 cm WIDTH								
		PLAIN DOOR		GLAZED DOOR				
		MOUNTING PLATE	MOUNTING FRAME INCLUDED	MOUNTING PLATE	MOUNTING FRAME INCLUDED			
2 ROW 45x80x22 cm		EE 2S 08 DP		EE 2S 08 DF		EE 2S 08 CP		EE 2S 08 CF
		EE 3S 08 DP		EE 3S 08 DF		EE 3S 08 CP		EE 3S 08 CF
3 ROW 60x80x22 cm		EE 4S 08 DP		EE 4S 08 DF		EE 4S 08 CP		EE 4S 08 CF
		EE 5S 08 DP		EE 5S 08 DF		EE 5S 08 CP		EE 5S 08 CF
4 ROW 75x80x22 cm		EE 6S 08 DP		EE 6S 08 DF		EE 6S 08 CP		EE 6S 08 CF
		EE 7S 08 DP		EE 7S 08 DF		EE 7S 08 CP		EE 7S 08 CF
5 ROW 90x80x22 cm								
6 ROW 105x80x22cm								
7 ROW 120x80x22 cm								



















Note: Wall mounting bracket set, cable gland plate, mounting frame or mounting plate are included.

40+80 cm WIDTH

	40+80 cm WIDTH			
	PLAIN DOOR		GLAZED DOOR	
	MOUNTING PLATE	MOUNTING FRAME INCLUDED	MOUNTING PLATE	MOUNTING FRAME INCLUDED
2 ROW 45x120x22 cm	 EE 2M 08 DP	 EE 2M 08 DF	 EE 2M 08 CP	 EE 2M 08 CF
3 ROW 60x120x22 cm	 EE 3M 08 DP	 EE 3M 08 DF	 EE 3M 08 CP	 EE 3M 08 CF
4 ROW 75x120x22 cm	 EE 4M 08 DP	 EE 4M 08 DF	 EE 4M 08 CP	 EE 4M 08 CF
5 ROW 90x120x22 cm	 EE 5M 08 DP	 EE 5M 08 DF	 EE 5M 08 CP	 EE 5M 08 CF
6 ROW 105x120x22 cm	 EE 6M 08 DP	 EE 6M 08 DF	 EE 6M 08 CP	 EE 6M 08 CF
7 ROW 120x120x22 cm	 EE 7M 08 DP	 EE 7M 08 DF	 EE 7M 08 CP	 EE 7M 08 CF

Note: The door of the narrow section is always projected to be plain.
 The narrow section is always projected to be plain mounting plate
 For different applications please, contact to your customer service representative.

COVER PLATE COMPONENTS

COVER PLATE FRAMES							
ROW	Rated Width			ROW	Rated Width		
	40 cm	60 cm	80 cm		40 cm	60 cm	80 cm
2 ROW	 EE CT 2S 04	 EE CT 2S 06	 EE CT 2S 08	5 ROW	 EE CT 5S 04	 EE CT 5S 06	 EE CT 5S 08
3 ROW	 EE CT 3S 04	 EE CT 3S 06	 EE CT 3S 08	6 ROW	 EE CT 6S 04	 EE CT 6S 06	 EE CT 6S 08
4 ROW	 EE CT 4S 04	 EE CT 4S 06	 EE CT 4S 08	7 ROW	 EE CT 7S 04	 EE CT 7S 06	 EE CT 7S 08

Note: 4 pieces of cover plate holder are included.

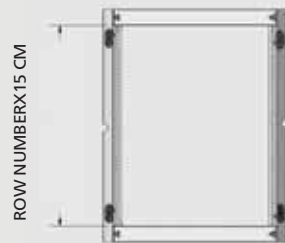
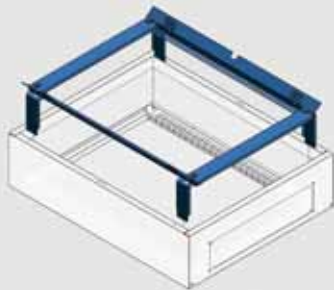



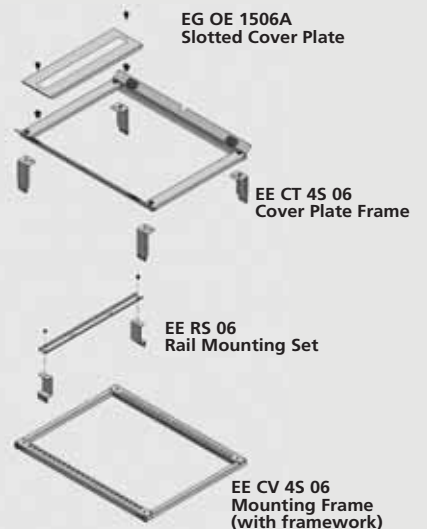
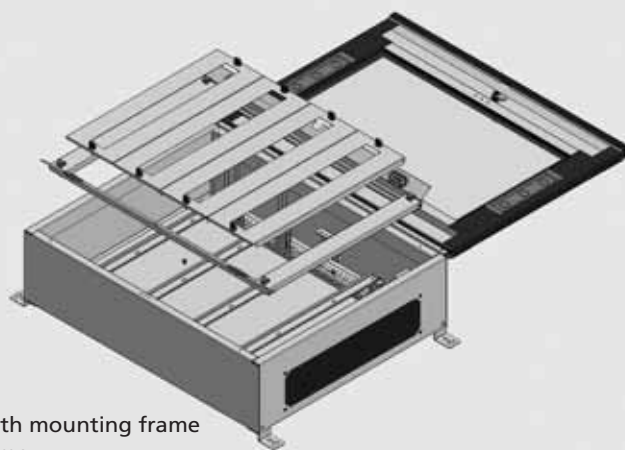







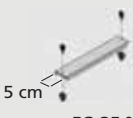
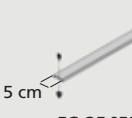

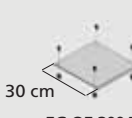
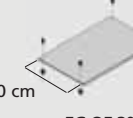
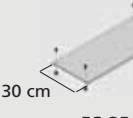
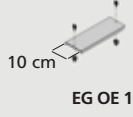

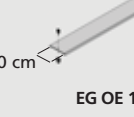



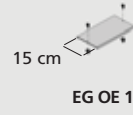

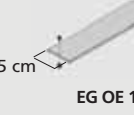
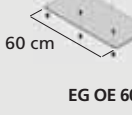
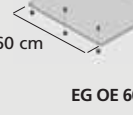

Example: Configuration of 4 ROWS

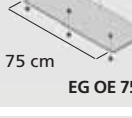
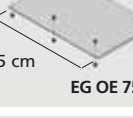
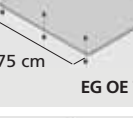

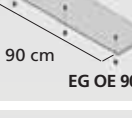
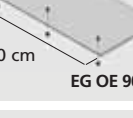
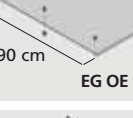
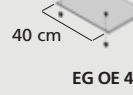
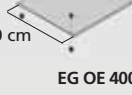

Order Information

- EE CF 4S 06 - Glazed door with mounting frame
- EE CT 4S 06 - Cover plate frame
- EE RS 06 - Rail mounting set - 4 pieces
- EG OE 1506A - Slotted cover plate - 4 pieces

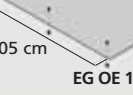

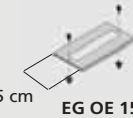
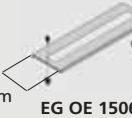
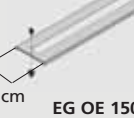
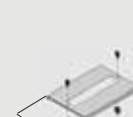
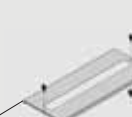

STANDARD COVER PLATES

h	Rated Width			h	Rated Width		
	40 cm	60 cm	80 cm		40 cm	60 cm	80 cm
5 cm	 EG OE 0504	 EG OE 0506	 EG OE 0508	30 cm / One piece of OE for 2 rows 45 cm / One piece of OE for 3 rows 60 cm / One piece of OE for 4 rows 75 cm / One piece of OE for 5 rows 90 cm / One piece of OE for 6 rows 105 cm / One piece of OE for 7 rows	 EG OE 3004	 EG OE 3006	 EG OE 3008
10 cm	 EG OE 1004	 EG OE 1006	 EG OE 1008		 EG OE 4504	 EG OE 4506	 EG OE 4508
15 cm	 EG OE 1504	 EG OE 1506	 EG OE 1508		 EG OE 6004	 EG OE 6006	 EG OE 6008
20 cm	 EG OE 2004	 EG OE 2006	 EG OE 2008		 EG OE 7504	 EG OE 7506	 EG OE 7508
25 cm	 EG OE 2504	 EG OE 2506	 EG OE 2508		 EG OE 9004	 EG OE 9006	 EG OE 9008
40 cm	 EG OE 4004	 EG OE 4006	 EG OE 4008		 EG OE 10504	 EG OE 10506	 EG OE 10508



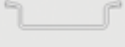
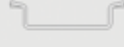
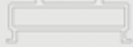

































SLOTTED COVER PLATES

	12 Units / 40 cm	24 Units / 60 cm	36 Units / 80 cm
15 cm	 EG OE 1504A	 EG OE 1506A	 EG OE 1508A
20 cm	 EG OE 2004A	 EG OE 2006A	 EG OE 2008A

RAIL MOUNTING SET

	12 Units / 40 cm	24 Units / 60 cm	36 Units / 80 cm
			 Aluminum Profile
	 EE RS 04	 EE RS 06	 EE RS 08

ORDER INFORMATION

	ONE PIECE OF MOUNTING FRAME			ONE PIECE OF MOUNTING PLATE		
2 ROW	 EE CV 2S 04	 EE CV 2S 06	 EE CV 2S 08	 EE MP 2S 04	 EE MP 2S 06	 EE MP 2S 08
3 ROW	 EE CV 3S 04	 EE CV 3S 06	 EE CV 3S 08	 EE MP 3S 04	 EE MP 3S 06	 EE MP 3S 08
4 ROW	 EE CV 4S 04	 EE CV 4S 06	 EE CV 4S 08	 EE MP 4S 04	 EE MP 4S 06	 EE MP 4S 08
5 ROW	 EE CV 5S 04	 EE CV 5S 06	 EE CV 5S 08	 EE MP 5S 04	 EE MP 5S 06	 EE MP 5S 08
6 ROW	 EE CV 6S 04	 EE CV 6S 06	 EE CV 6S 08	 EE MP 6S 04	 EE MP 6S 06	 EE MP 6S 08
7 ROW	 EE CV 7S 04	 EE CV 7S 06	 EE CV 7S 08	 EE MP 7S 04	 EE MP 7S 06	 EE MP 7S 08

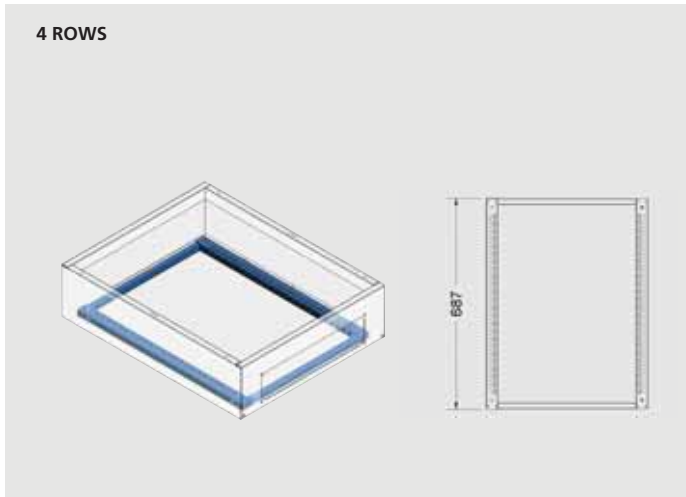

Example: Configuration of 4 ROWS

Cover frame can be mounted on the piece mounting plates

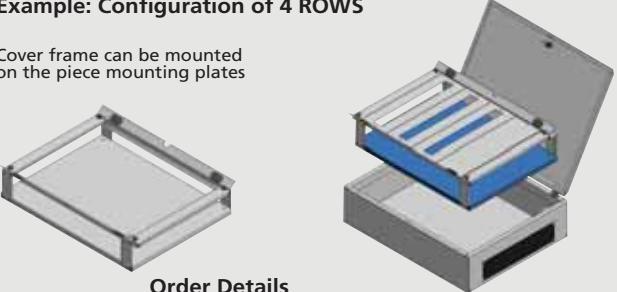

Order Details

- EE 4S 06 DP - Plain Door With Mounting Plate
- EE CT 4S 06 - Cover Frame
- EE RS 06 - Rail Mounting Set - 4 Pieces
- EE OE 1506 A - Slotted Cover Plate - 3 Pieces
- EE OE 1506 - Plain Cover Plate - 1 Piece

ACCESSORIES

Supporting separation component

40 cm for width EE TB 04
60 cm for width EE TB 06
80 cm for width EE TB 08

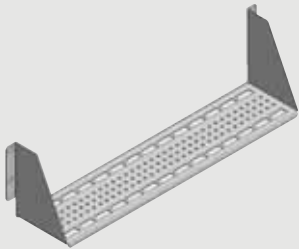

Supporting separation element can be used with different purposes.

For example:

- As support for capacitors in compensation applications.
- As separator between circuits having different functions like power circuits and CCTV circuits

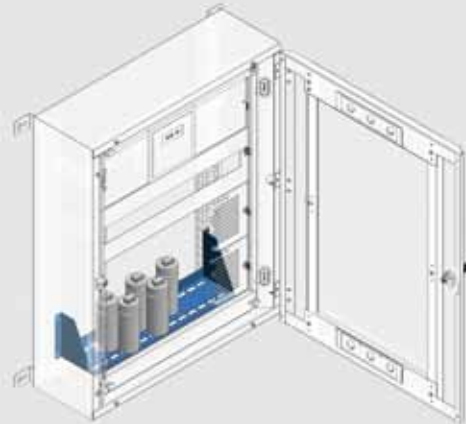

Plinth unit

For width 40 cm EE BZ 04
For width 60 cm EE BZ 06
For width 80 cm EE BZ 08
For width 100 cm EE BZ 64
For width 120 cm EE BZ 84



Wall fixing rail set

For 2 rows EE DM 2S
For 3 rows EE DM 3S
For 4 rows EE DM 4S
For 5 rows EE DM 5S
For 6 rows EE DM 6S
For 7 rows EE DM 7S



Cable cover unit

For width 40 cm EE KB 04
For width 60 cm EE KB 06
For width 80 cm EE KB 08
For width 100 cm EE KB 64
For width 120 cm EE KB 84



EE RP Rubber cable gland plate

EE RP 04

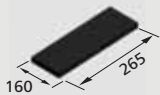

EE RP 06

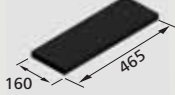

EE RP 08

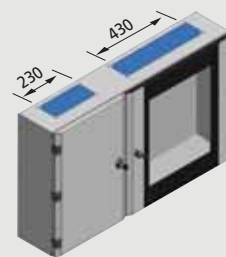

EG ACT directional fixing



Example of internal assembly

Example: EE 4S 06 CF
EG MP 2005- Mounting Plate
EG DST 100 - Depth Adjustment Bracket

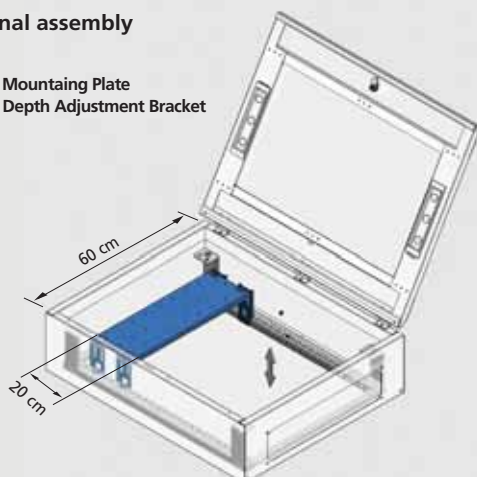

Notes: EE rated width dimensions of the general internal assembly

Baying kit EE PB 01



Unless otherwise specified all dimensions are in mm.

CUSTOM SOLUTIONS

Example of building application

For custom applications with large numbers, contact to your sales representative.
Dimensions are given as example.

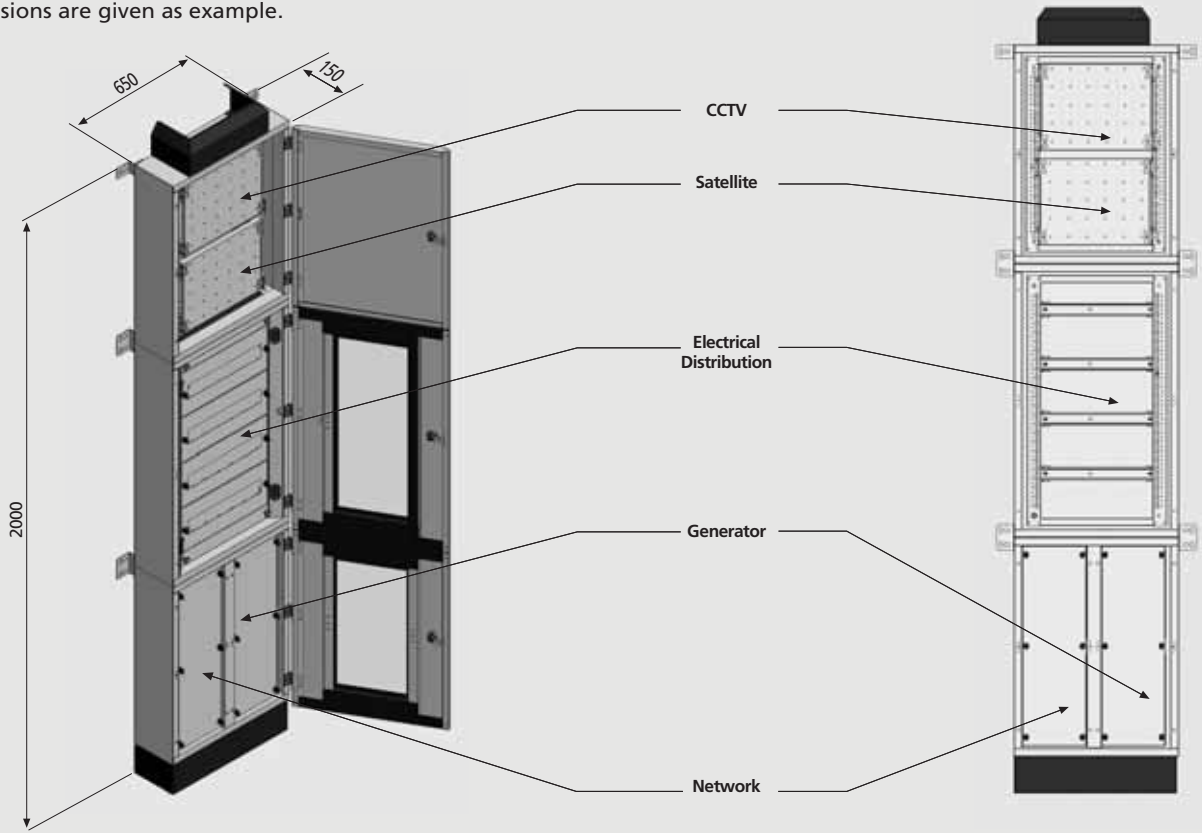

Example of metering application

For custom of metering applications with large numbers, contact to your sales representative.

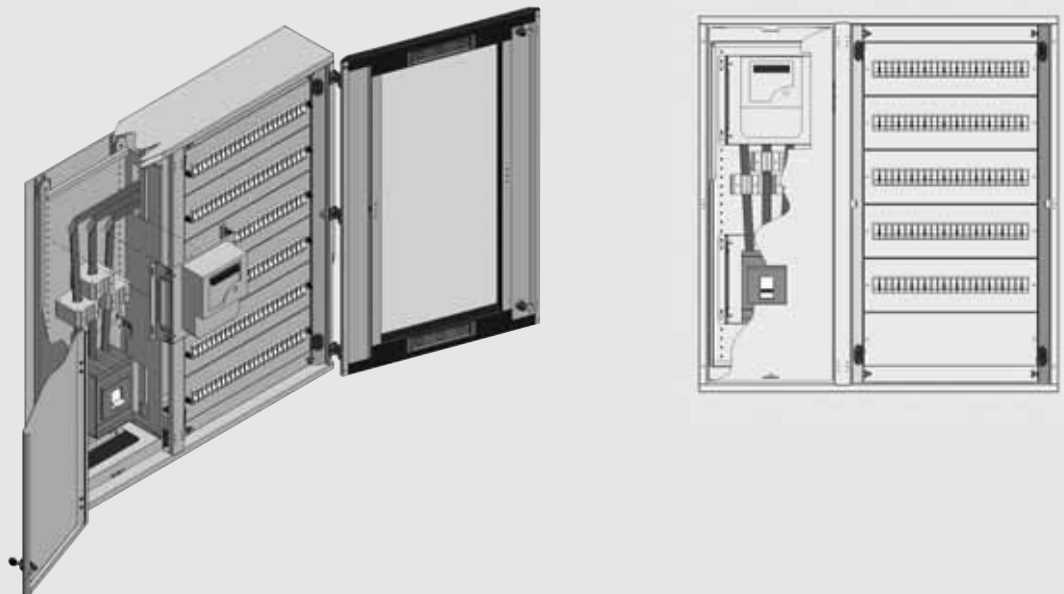

Unless otherwise specified all dimensions are in mm.

ALTERNATIVEPRODUCTSOLUTIONS

E-KABIN S
Standing Type Modular Enclosures
IP 55

E-KABIN D
Standing Type Modular Enclosures
IP 41

E-KABIN M
Monoblock Type Enclosures
IP 66

E-KABIN O
Monoblock Type Enclosures
IP 66

E-KABIN H
Outdoor Type Enclosures
IP 55 - 66

E-KABIN X
Stainless Steel Type Enclosures
IP 55 - 67

E-KABIN K
Control Consoles
IP 55

E-KABIN T
Terminal Boxes
IP 67

E-KABIN A
Aluminum Enclosures
IP 55 - IP 67

E-KABIN B
Busbar Supports
Type Tested and Certified



ELEKTROTEKNİK

www.eae-et.com.tr

EAE Elektroteknik A.Ş.
İkitelli Organize Sanayi Bölgesi
Ziya Gökalp Mahallesi
Eski Turgut Özal Caddesi No:20
34490 Başakşehir / İstanbul
Tel : +90 (212) 549 26 39 (Pbx)
Fax : +90 (212) 549 37 91
E-mail : ekabin@eae.com.tr
Web : www.eae-et.com.tr